

Cerniere, braccetti e chiusure / Cerniera e basette X91 con chiusura soft / Cerniera X91 con scodellino Ø35, apertura a 105° / Collo dritto X91

Scheda tecnica del prodotto



Collo dritto X91

Cerniera X91 con scodellino Ø35, apertura a 105°



Specificazioni

Descrizioni		Cod.	Finitura
Per vite	200	1040007	Nichelato
A pressione	200	1040107	Nichelato

Schema

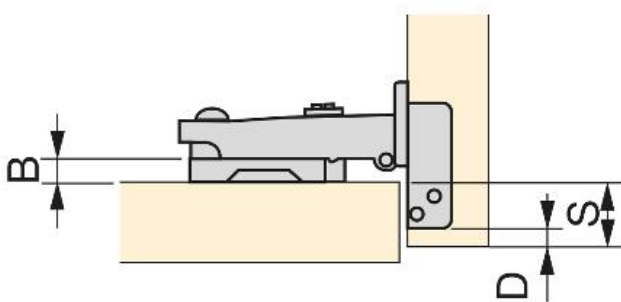

$$B = 15 + D - S$$

Informazioni

Braccetto ammortizzatore per chiusura soft della porta.

Sistema automatico di montaggio della cerniera sulla basetta.

Spessore della porta da 14 a 24 mm.

Regolabile tridimensionalmente.

Tolleranza di foratura dello scodellino D = 3 ~ 7 mm.

Regolazione in profondità mediante eccentrico.

Molla in apertura e chiusura.

Per il montaggio si raccomanda l'utilizzo di viti TSP $\varnothing 4 \times 16$ Cod. 5032305 o TGS $\varnothing 4 \times 15$ Cod. 5000907 - $\varnothing 3,5 \times 16$ Cod. 5000807.

Montaggio

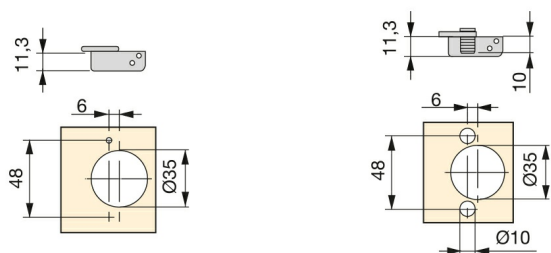

Prodotti fondamentali

Piastra braccio acciaio



	Cod.	Finitura
1000	1239707	Nichelato

Tornillo de cabeza plana $\varnothing 4 \times 16$



	Cod.	Finitura
1000	5032305	Zincato bianco

Viti Plus TGS



D	Ø	L		Cod.	Finitura
7,9	4	15	500	5000907	Nichelato
6,5	3,5	16	500	5000807	Nichelato

Basetta X91 per vite



Altezza		Cod.	Finitura
0	200	1041107	Nichelato
2	200	1041207	Nichelato
4	200	1042607	Nichelato

Basetta X91 a pressione



Altezza		Cod.	Finitura
0	200	1042207	Nichelato
2	200	1042307	Nichelato

Basetta X91 montaggio misto



Altezza	P		Cod.	Finitura
0	9,5	200	1042407	Nichelato
2	9,5	200	1042507	Nichelato
0	7,8	200	1043307	Nichelato
2	7,8	200	1043407	Nichelato

Basetta X91 Euro



Altezza		Cod.	Finitura
0	200	1041307	Nichelato
2	200	1041407	Nichelato

Basetta X91 con regolazione eccentrica per vite



Altezza		Cod.	Finitura
0	200	1041507	Nichelato
2	200	1041607	Nichelato

Basetta X91 con regolazione eccentrica a pressione



Altezza		Cod.	Finitura
0	200	1042707	Nichelato

Basetta X91 con regolazione eccentrica Euro



Altezza		Cod.	Finitura
0	200	1041707	Nichelato
2	200	1041807	Nichelato